



Page 20-4

MICRO PLCs

- 10 Inputs/Outputs (LRD10...)
- 12 Inputs/Outputs (LRD12...)
- 20 Inputs/Outputs (LRD20...)
- 12VDC, 24VDC, 24VAC or 100-240VAC power supply
- Relay or transistor outputs.



Page 20-4

EXPANSION AND COMMUNICATION MODULES

- 8 digital inputs/outputs
- 24VDC, 24VAC or 100-240VAC power supply
- Analog inputs, 0...10V or 0...20mA
- Analog outputs, 0...10V or 0...20mA
- Relay or transistor outputs
- PT100 temperature sensor inputs
- Modbus®-RTU protocol slave communication unit.

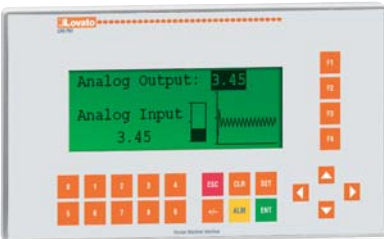

Page 20-5

ACCESSORIES

- Program backup memory
- Programming and supervision software
- Power supply unit
- HMI operator panel with graphic LCD.



Page 20-5

STARTER KITS

- Complete kit to begin using micro PLCs
- Each equipped with LRD relay, programming-supervision software and USB connecting cable.



- 10, 12 and 20 Input-Output base units
- Expansion modules with 4 digital Inputs and 4 digital Outputs
- Expansion modules with analog Inputs-Outputs
- Modbus-RTU communication module
- RS232/USB serial interface port for PC, HMI operator panel or program backup memory connection
- On-board programming languages: Italian, English, Spanish, French, German, Portuguese and Chinese
- PC programming languages: Italian, English and Spanish.

Micro PLCs

	SEC. - PAGE
Base modules	20 - 4
Expansion and communication modules.....	20 - 4
Accessories	20 - 5
Starter kits	20 - 5
Dimensions	20 - 6
Wiring diagrams	20 - 6
Technical characteristics	20 - 6

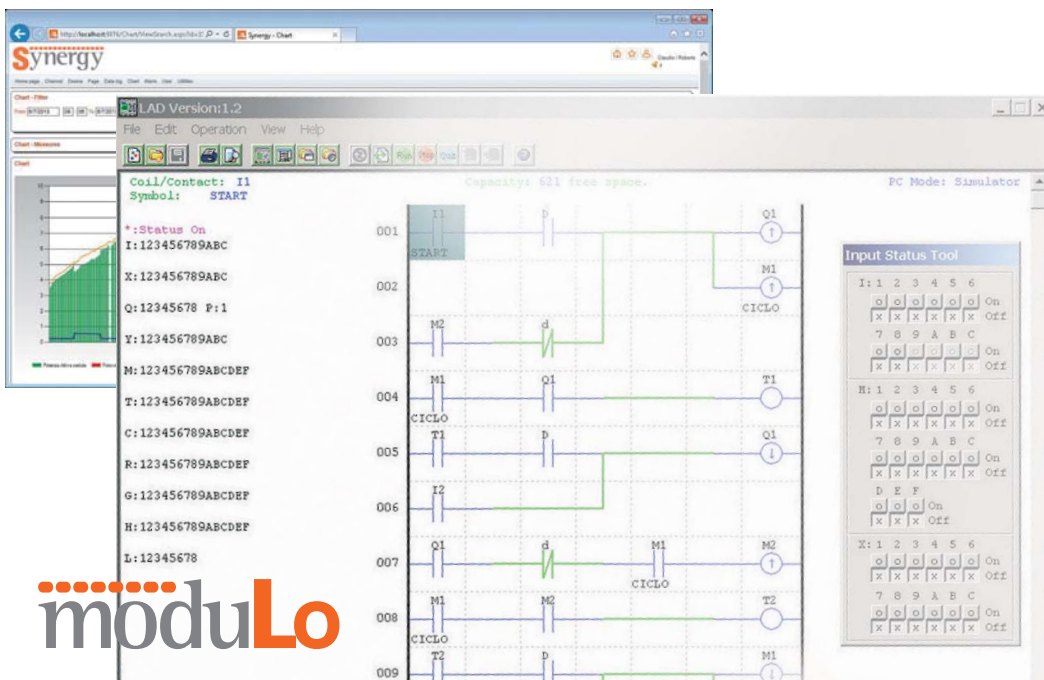

MICRO PLC - EXCEPTIONAL PERFORMANCE!



- **SYSTEM CONTROL AND SUPERVISION**
 - Contact status viewing in simple and small screen display
 - Faculty to add the micro PLC to systems integrated on data networks. By using Synergy supervision software, a multiclient structure can also be managed through Web interface.
- **QUICK CONTROL BOARD INSTALLATION**
 - Fewer number of components
 - Less wiring with minor number of connections.
- **REPETITIVENESS**
 - Less errors during panel building
 - Considerable time saving.
- **FLEXIBILITY**
 - Quick correction of abnormal conditions at final testing
 - Fast changes on control boards.

● **FUNCTION BLOCKS AND MEMORY**

Timer (T) (delay on/off, recycle, pulsing, ...)	31
Real Time Clock (RTC) (daily, weekly, monthly and yearly mode)	31
Counter (C)	31
Analog comparator (G)	31
User's pages (H) - 16 characters - 4 lines	31
Auxiliary relay - Scratchpad (M + N memory types)	63 + 63
Data register (DR)	240
Saving can be in memory storage of:	
- Auxiliary relay	
- Counter value	
- Data register.	

● **PROGRAM SIZE**

Language	
LADDER (contact scheme)	300 lines
FBD (function blocks)	260 blocks

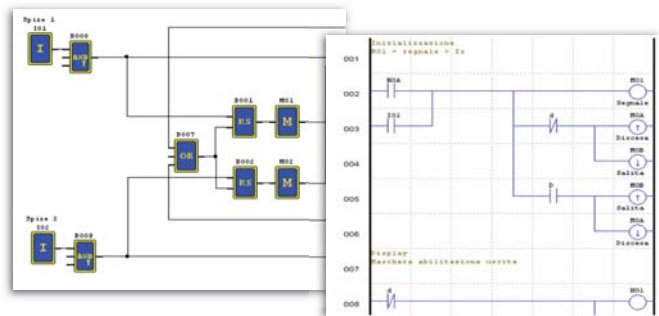

FUNCTIONS

● **PWM OUTPUT**

Pulse train generation with programmable pulse time and frequency

$$V_{out} = 24VDC \times \frac{T_{on}}{T}$$

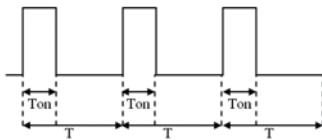

● **HIGH SPEED INPUT**

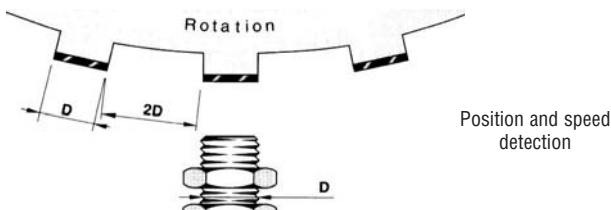

● **PID**

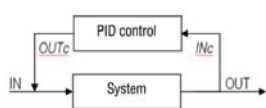

IN: Heating switch on and required temperature setting
 OUT: Current room temperature
 INc: Measured room temperature in an exact spot
 OUTc: Temperature adjusting and controlling.

● **MULTIPLEXER**

Selection of 1 of 4 values based on the combination of two digital signals

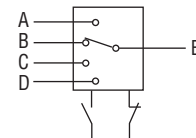

● **SHIFT FUNCTION** - activation of pulsed outputs in sequence

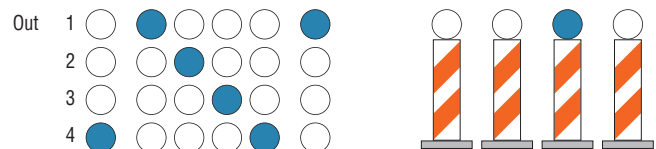

● **BOOLEAN LOGIC BLOCKS**

Output activation based on a series of digital signals

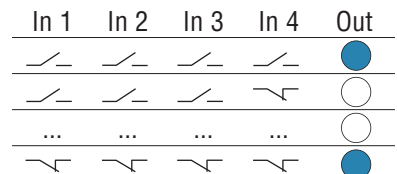

OPERATOR PANEL LRX P01

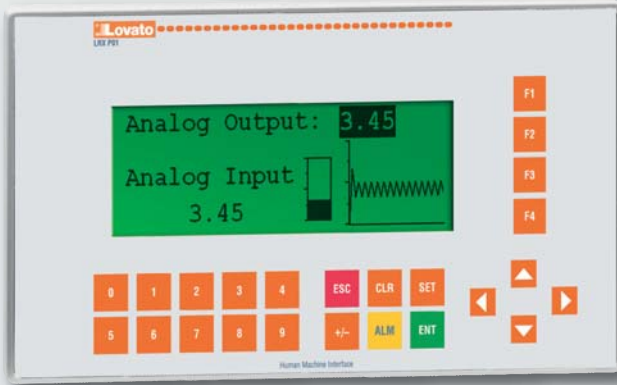

HMI INTERFACE

LRX P01 is an HMI operator panel, used with many types of PLCs or other intelligent controllers equipped with communication port. By using the HMI, the values of both PLC inner registers and relay status can be monitored and changed with the keys or LEDs. In this way, machinery and equipment functioning results to be simple and direct. The LRX SW P01 editor software permits to make dedicated screens by taking advantage of the graphic display to view bitmaps, bar graphs and trend lines.

BACKLIGHT 192x64 PIXEL GRAPHIC LCD

Read numerical values	Static text	Dynamic text	Read status (bits)	Commands	
Images				Display bar graphs and trend lines	Write numerical values

COMMUNICATION MODES

LRX P01 supports Modbus-RTU protocol and different communication modes can be chosen, such as RS232 and RS485.

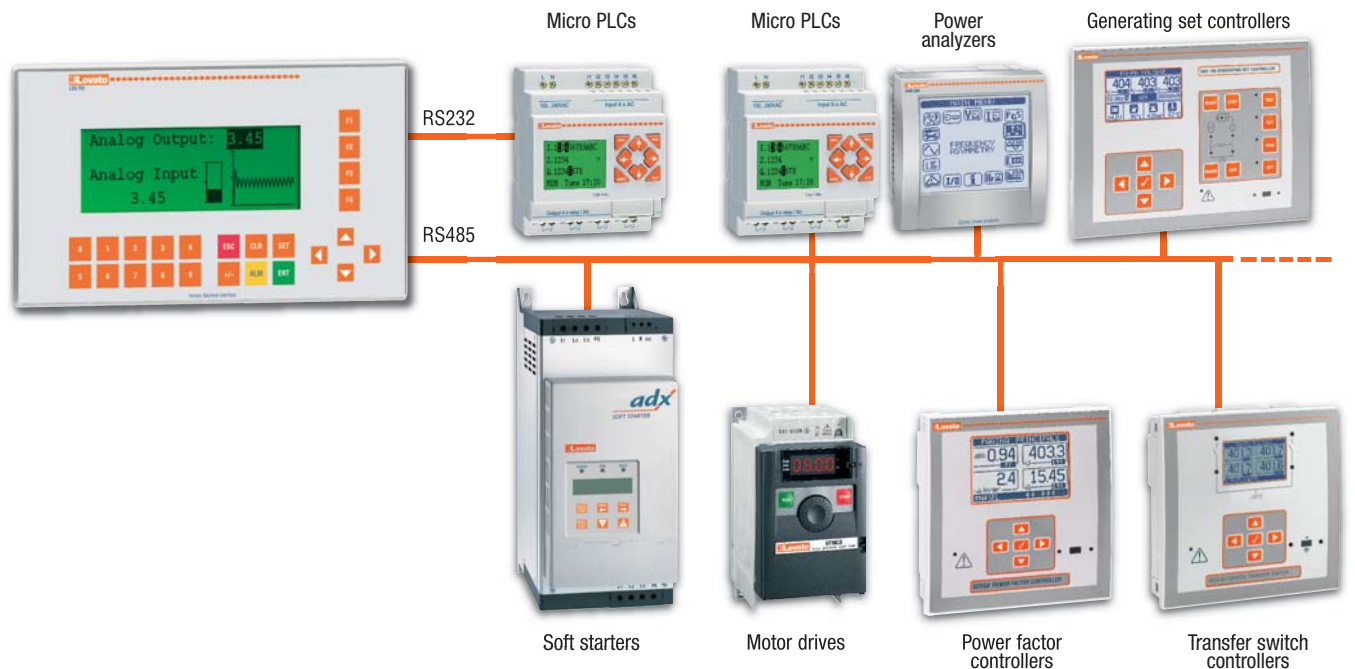

Base modules



LRD10...
LRD12...



LRD20R D024 P1

Order code	Auxiliary supply voltage	In/Out ^①	Qty per pkg	Wt
			n°	[kg]
Base modules.				
LRD12R D024	24VDC	8/4 relay	1	0.241
LRD12T D024	24VDC	8/4 transistor	1	0.220
LRD20R D024	24VDC	12/8 relay	1	0.360
LRD20R D024 P1 ^②	24VDC	12/8 relay	1	0.360
LRD12R A024	24VAC	8/4 relay	1	0.250
LRD20R A024	24VAC	12/8 relay	1	0.368
LRD10R A240	100-240VAC	6/4 relay	1	0.242
LRD20R A240	100-240VAC	12/8 relay	1	0.367
LRD20R D012	12VDC	12/8 relay	1	0.252

① Inputs/Outputs.
② With RS485 onboard.

General characteristics

FUNCTIONS

- Addition-Subtraction on variables
- Multiplication-Division on variables
- Comparator on variables
- HMI display for parameter viewing and programming
- PWM output
- High speed input (1kHz)
- PID function
- Multiplexer
- Analog ramp
- Register transfer (numerical variables and status)
- Shift function
- Boolean logic blocks
- LRD20R D024 P1 with RS485 port onboard.

Operational characteristics

- 8A lth current relay outputs for AC and DC versions
- 0.3A 24VDC transistor outputs for DC version
- 0-10V analog inputs for DC version
- Version: modular for mounting on 35mm DIN rail (IEC/EN 60715) or M4x15mm screw fixing
- Type of terminal: Screw
- IEC degree of protection: IP20.

Certifications and compliance

Certifications obtained: UL Listed, for USA and Canada (cULus - File E300049), as Programmable Controllers. Compliant with standards: IEC/EN 61131-2, UL508, CSA C22.2 n°142.

Expansion and communication modules



LRE...

Order code	Auxiliary supply voltage	In/Out ^①	Qty per pkg	Wt
			n°	[kg]
Expansion and communication modules ^② .				
LRE02A D024	24VDC	2 analog outputs 0...10V/0...20mA	1	0.160
LRE04A D024	24VDC	4 analog outputs 0...10V/0...20mA	1	0.160
LRE04P D024	24VDC	4 PT100 temp. sensor inputs	1	0.160
LRE08R D024	24VDC	4/4 relay	1	0.171
LRE08T D024	24VDC	4/4 transistor	1	0.151
LRE08R A024	24VAC	4/4 relay	1	0.180
LRE08R A240	100-240VAC	4/4 relay	1	0.180
LRE P00		Modbus-RTU protocol communication unit	1	0.134

① Inputs/Outputs.
② The expansion modules are supplied with connector for base module.

INPUTS/OUTPUTS REFERENCE TABLE

BASE MODULES				BASE + DIGITAL EXPANSIONS
Type	Power supply	Inputs	Outputs	Max I/O
LRD12RD012	12VDC	8 digital + 4 digital/analog	8 relay	20 + 24 ^④
LRD12RD024	24VDC	6 digital + 2 digital/analog	4 relay	12 + 24
LRD12TD024	24VDC	6 digital + 2 digital/analog	4 transistor	12 + 24
LRD20RD024	24VDC	8 digital + 4 digital/analog	8 relay	20 + 24
LRD20RD024P1	24VDC	8 digital + 4 digital/analog	8 relay	20 + 24
LRD10RA240	100-240VAC	6 digital	4 relay	10 + 24
LRD20RA240	100-240VAC	12 digital	8 relay	20 + 24
LRD12RA024	24VAC	8 digital	4 relay	12 + 24
LRD20RA024	24VAC	12 digital	8 relay	20 + 24
EXPANSION AND COMMUNICATION MODULES				
LRE02AD024	24VDC	—	2 analog	—
LRE04AD024	24VDC	4 analog	—	—
LRE04PD024	24VDC	4 PT100	—	—
LRE08RD024	24VDC	4 digital	4 relay	—
LRE08TD024	24VDC	4 digital	4 transistor	—
LRE08RA240	100-240VAC	4 digital	4 relay	—
LRE08RA024	24VAC	4 digital	4 relay	—
LREP00	24VDC	RS485 Modbus-RTU protocol slave communication unit		

④ Expansion modules supplied at 24VDC.

Accessories



LRX 1V3 D024



LRX C00



LRX P01



LRX C02

Order code	Description	Qty per pkg	Wt
		n°	[kg]
Accessories.			
LRX M00	Program backup memory	1	0.011
LRX C00	PC (RS232)-LRD connecting cable, 1.5m/5ft long	1	0.083
LRX C03	PC (USB)-LRD connecting cable, 1.5/5ft long	1	0.080
LRX SW	Programming and supervision software (CD-ROM)	1	0.057
LRX 1V3 D024	Power supply unit, 100-240VAC/24VDC, 1.3A	1	0.220
LRX D00	User's manual Italian edition (paper)	1	0.400
LRX D01	User's manual English edition (paper)	1	0.400
LRX D02	User's manual Spanish edition (paper)	1	0.400
LRX D03	User's manual French edition (paper)	1	0.400
LRX P01	HMI operator panel, 24VDC, RS232, RS485 (Modbus®-RTU Master)	1	0.200
LRX C02	PC-LRX P01 connecting cable	1	0.180
LRX SW P01	LRX P01 editor software (CD-ROM)	1	0.057

Power supply unit and backup memory characteristics

- The LRX 1V3 D024 power supply produces a direct-current voltage to power the Kinco base and expansion modules in circumstances when 24VDC is not available in the application. The power supply can also be used to power eventual 24VDC auxiliary circuits.
- The LRX M00 backup memory allows to save the user's program and to simply and quickly transfer it to the base modules.

LRX P01 panel general characteristics

- 24VDC power supply
- RS232 communication port:
 - Direct connection to Kinco using LRX C00
 - Connection to other devices using a standard D-SUB 9 serial cable
- RS485 communication port
- LRX SW P01 editor software for specific pages and easy use.

FUNCTIONS

- Send commands
- Read status
- Provide static and dynamic texts
- Write variables
- Read variables:
 - Numerical value
 - Bar graph
 - Trend line.

Programming

At any time and with extreme simplicity, Kinco can be set up and reprogrammed to satisfy new requirements and improve the operation of a system.

Programming is simple and intuitive and can be done directly on the base module keypad or by personal computer, connected by LRX C00 (RS232) or LRX C03 (USB) interface and using the relative LRX SW software. With a personal computer, two programming language locs can be used: FBD (Function Block Diagrams) and LADDER (contact scheme).

Both of the following can be accomplished:

- Simulate the program directly "off-line" on a personal computer to test if it runs correctly.
- Use the supervision mode to check the project "on-line".

There are 8 function keys on front, dedicated to on-board adjustment, control and supervision of digital input and output status, analog input values, time and date entry and the operation status of the Kinco itself.

Certifications and compliance

Certifications obtained: UL Listed, for USA and Canada (cULus - File E300049), as Programmable Controllers for power supply and HMI units and base module of kits. Compliant with standards: IEC/EN 61131-2, UL508, CSA C22.2 n°142.

Starter kits



Starter kits.

LRDKIT 12R D024	LRD starter kit complete with LRD12R D024 base module, LRX SW software and LRX C03 cable	1	0.424
LRDKIT 12R A024	LRD starter kit complete with LRD12R A024 base module, LRX SW software and LRX C03 cable	1	0.424
LRDKIT 10R A240	LRD starter kit complete with LRD10R A240 base module, LRX SW software and LRX C03 cable	1	0.424

Maximum combinations

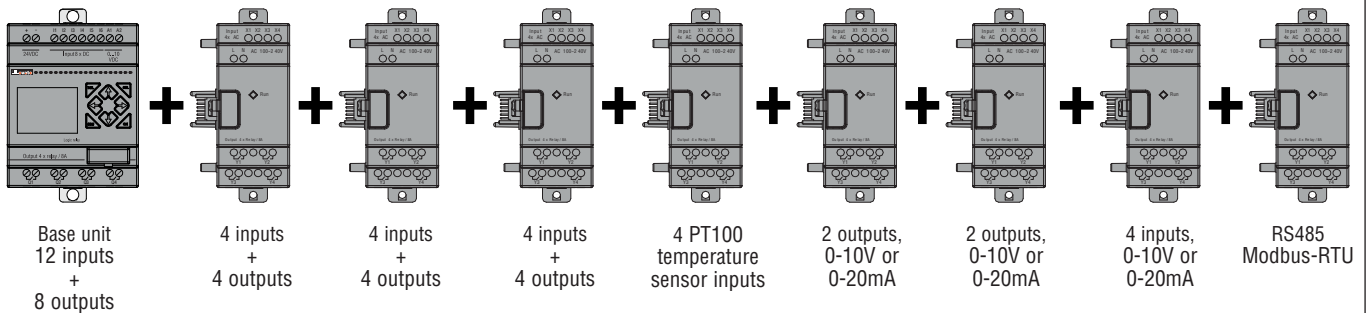

- 24 digital inputs (4 configurable as analog 0-10V input)
- 20 digital outputs (relay, transistor or mixed)
- 4 analog inputs for PT100 temperature sensors

- 4 analog outputs configurable as 0-10V or 0/4-20mA
- 4 analog inputs configurable as 0-10V or 0/4-20mA
- 1 RS485 slave communication module.

N.B. The sequence of the products given above must be respected for correct operation.

BASE MODULES

LRD10... - LRD12...

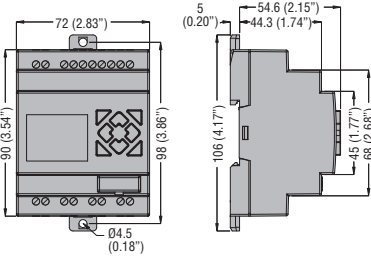

LRD20...

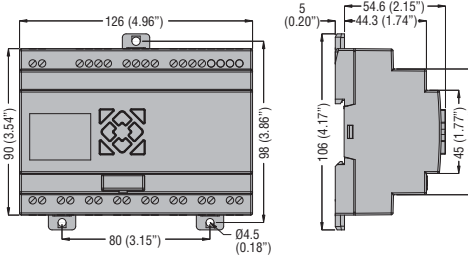

LRE... expansion/communication module

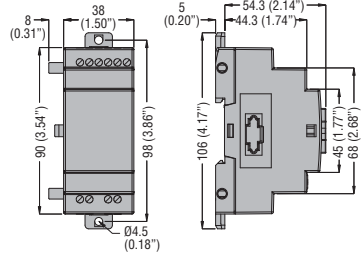

LRX1V3 D024 power supply unit

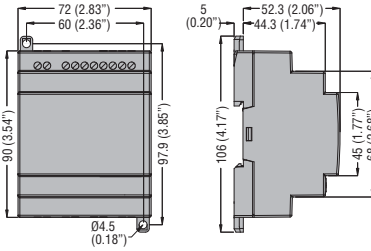

LRX P01 HMI operator panel

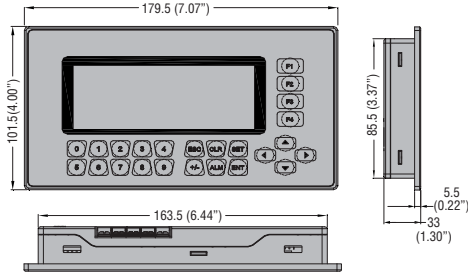

Cutout

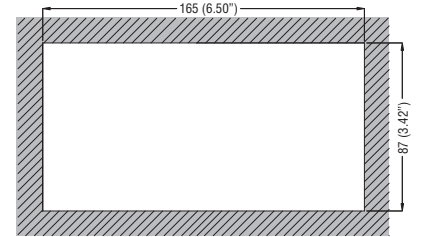

Wiring diagrams

BASE MODULES

LRD12R D024

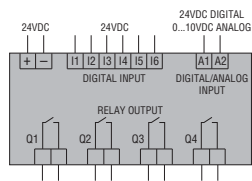

LRD12T D024

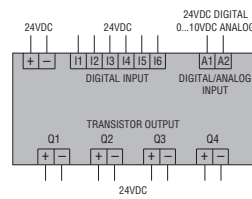

LRD12R A024

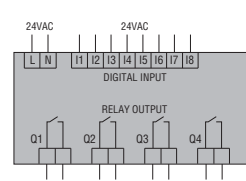

LRD10R A240

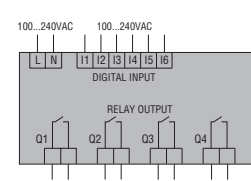

LRD20R D012 - LRD20R D024

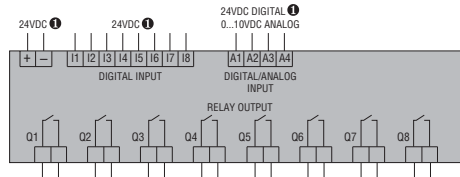

① 12VDC for LRD20R D012.

LRD20R D024 P1

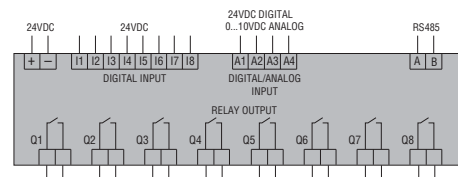

LRD20R A024

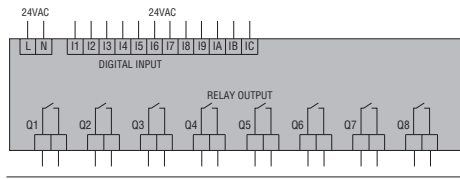

LRD20R A240

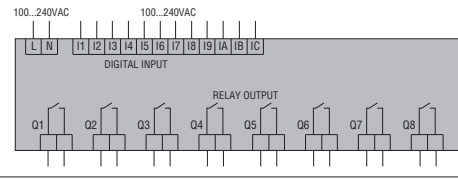

Expansion and communication modules

LRE02A D024

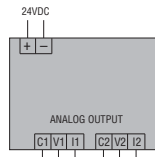

LRE04A D024

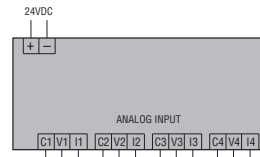

LRE04P D024

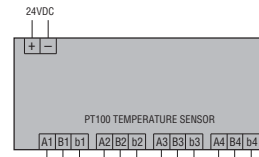

LRE08R D024

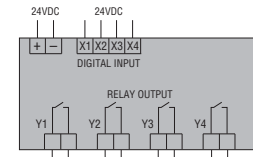

LRE08T D024

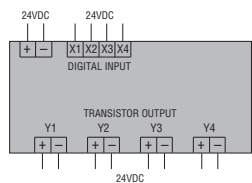

LRE08R A024

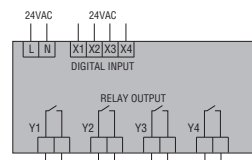

LRE08R A240

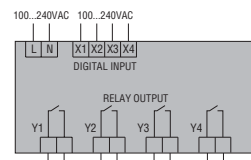

Accessories

LRX 1V3 D024

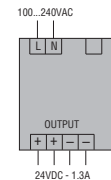

LRX P00 - LRX P01

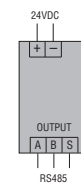

BASE MODULE TYPE		LRD... D012	LRD... D024	LRD... A024	LRD... A240
POWER SUPPLY					
IEC rated voltage Ue (frequency range)		12VDC	24VDC	24VAC (50-60Hz)	100-240VAC (50-60Hz)
Operating limits		10.4-14.4VDC	20.4-28.8VDC	20.4-28.8VAC (47-63Hz)	85-265VAC (47-63Hz)
Average current consumption		265mA	125mA (LRD12...) 185mA (LRD20...)	290mA	100mA
DIGITAL INPUTS					
Rated voltage		12VDC	24VDC	24VAC (50-60Hz)	100-240VAC (50-60Hz)
Input voltage	State 0	< 2.5VDC	< 5VDC	< 6VAC	< 40VAC
	State 1	> 7.5VDC	> 15VDC	> 14VAC	> 79VAC
Delay time	0 to 1	4ms (0.5ms for high speed)	4ms (0.5ms for high speed)	90ms	50/45ms (Ue=120VAC) - 22/18ms (Ue=240VAC)
	1 to 0	4ms (0.3ms for high speed)	4ms (0.3ms for high speed)	90ms	50/45ms (Ue=120VAC) - 90/85ms (Ue=240VAC)
ANALOG INPUTS FOR DC VERSIONS ONLY					
Input signal range		0-10V		—	—
Display resolution		0.01V		—	—
Conversion		12bit		—	—
Current consumption at 10VDC		< 0.17mA		—	—
Input impedance		< 1kΩ		—	—
Admissible overload		14VDC	28VDC	—	—
Sampling time		5-20ms (LADDER); 2-10ms (FBD)			
Maximum cable length		≤ 30m/98ft of screened type		—	—
DIGITAL OUTPUTS					
Type of output / IEC rated current Ith		Relay / 8A (LDR...R... / LRE08R... only) Transistor / 0.3A 24VDC (LRD...T... / LRE08T... only)			
Applied voltage		12-240VAC / 12-30VDC (LDR...R... / LRE08R... only) 10-28.8VDC (LRD...T... / LRE08T... only)			
AMBIENT CONDITIONS					
Operating temperature		-20...+55°C			
Storage temperature		-40...+70°C			
Relative humidity		20-90% without condensation			
HOUSING					
Version		Modular for mounting on 35mm DIN rail (IEC/EN 60715) or M4x15mm screw fixing			
Connections	Type of terminal	Screw			
	Conductor section	0.14-2.5mm ² / 26-14AWG			
	Tightening torque	0.6Nm / 0.4lbf			
	Maximum cable length	≤ 100m/328ft			
IEC degree of protection		IP20			

EXPANSION MODULE TYPE		LRE02A D024		LRE04P D024	
POWER SUPPLY					
IEC rated voltage Ue		24VDC		24VDC	
Operating limits		20.4-28.8VDC		20.4-28.8VDC	
ANALOGIC INPUTS/OUTPUTS					
Type of channels		2 outputs configurable for voltage or current		4 inputs for PT100 temperature sensors	
Operating limits		0-10V	0-20mA	-100...+600°C	
Digital output		0.00-10.00V	0.00-20.00mA	-100.0...+600.0°C	
Resolution		10mV	40μA	0.1°C	
Accuracy		±2.5%		±1%	
Power consumption		70mA		70mA	